

Verboot™

INSTRUCTION MANUAL

TABLE OF CONTENTS

IDENTIFICATION OF PARTS	2
BATTERY INSERTION	4
BATTERY REPLACEMENT	6
OPERATION	7
ARM ADJUSTMENT	12
HINTS, TIPS & REMINDERS	13
CHECKLIST FOR CORRECTING DISORDERS	14
CARE & MAINTENANCE	16
HOW VERBOT RECOGNIZES YOUR VOICE	17
GAMES	18

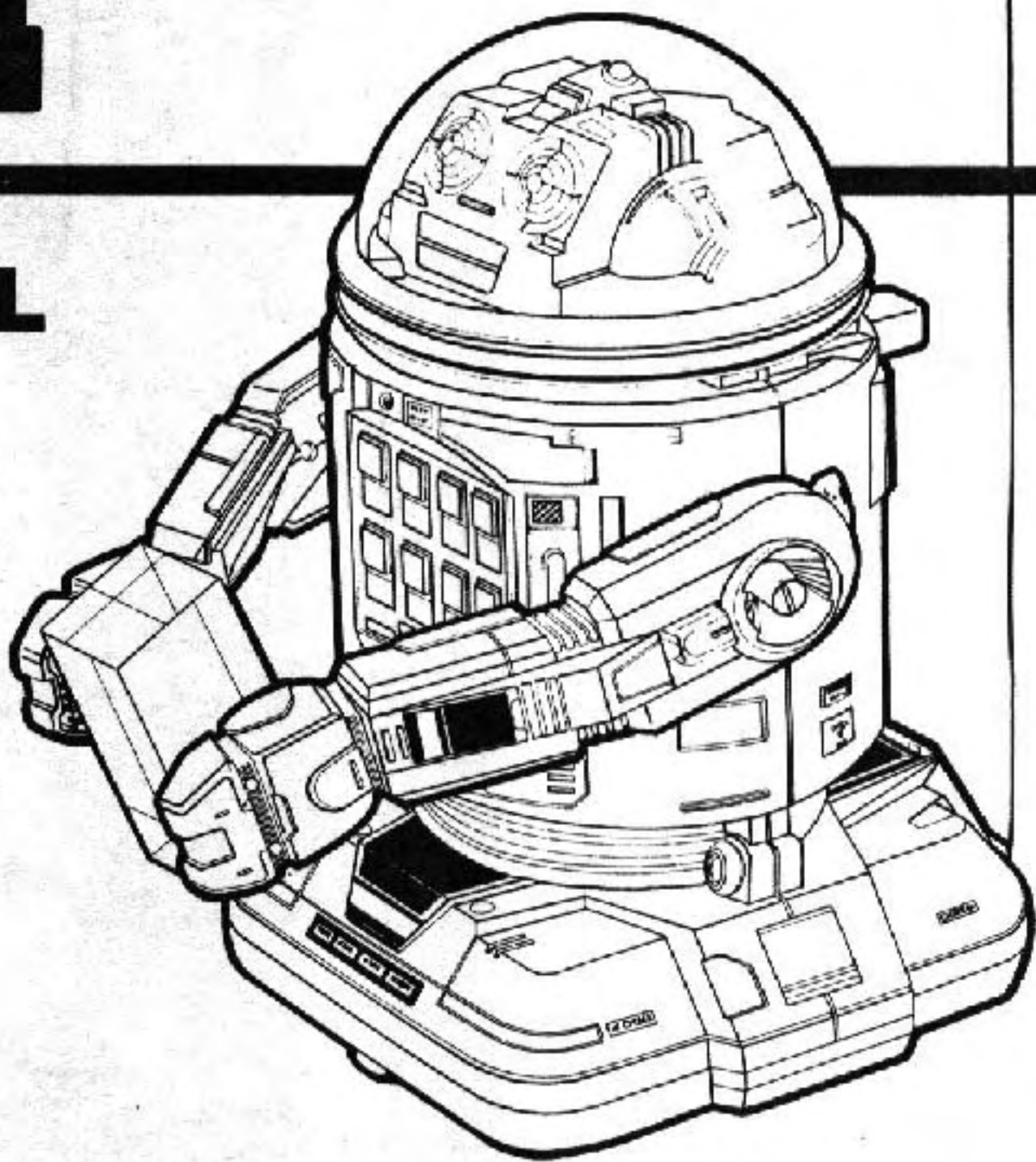

TOMY®

No. 5401 (2)

Frequency: 49.860MHz

IDENTIFICATION OF PARTS

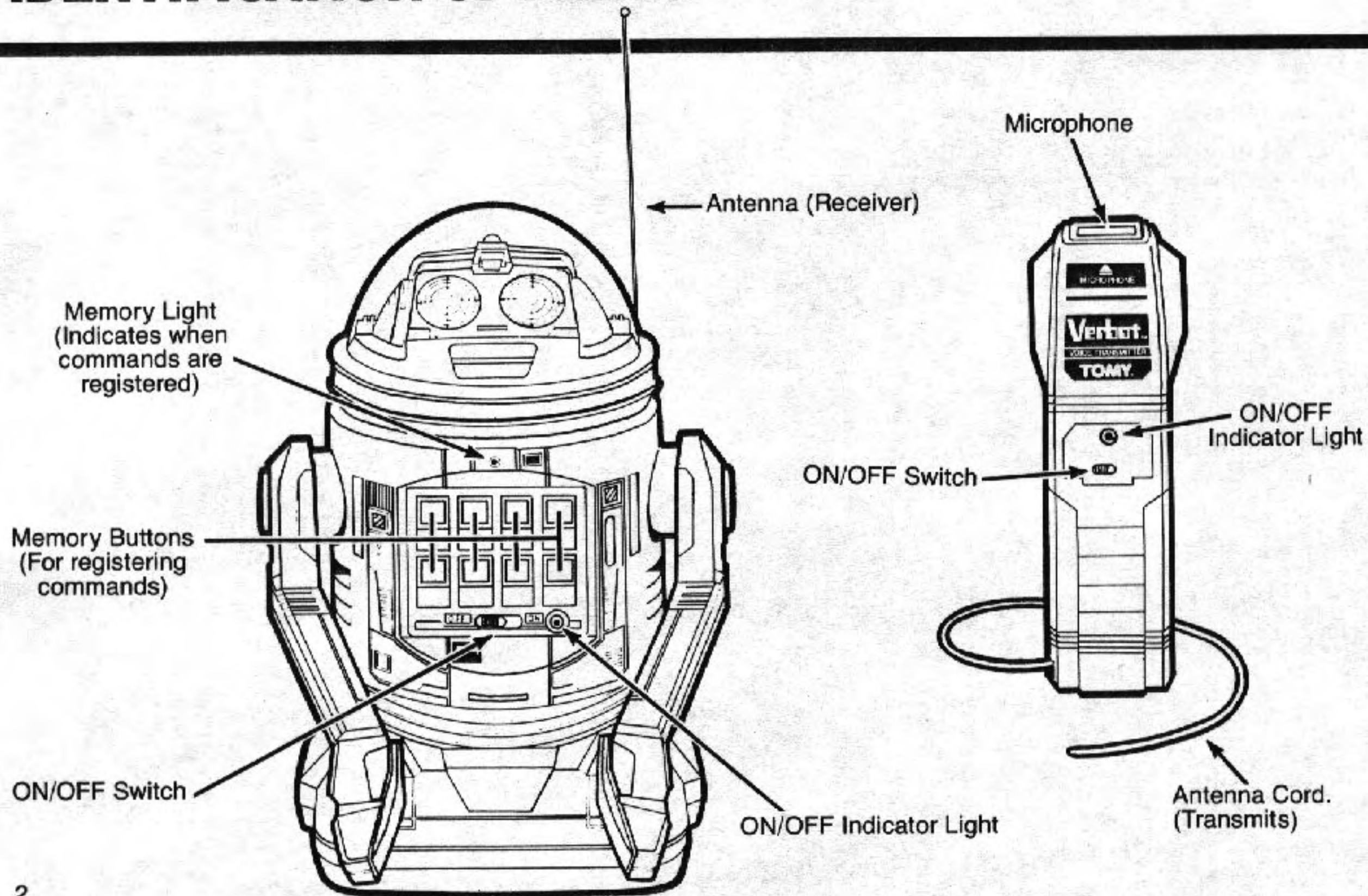

IDENTIFICATION OF PARTS

DECAL SHEET

Peel and place decals as indicated.

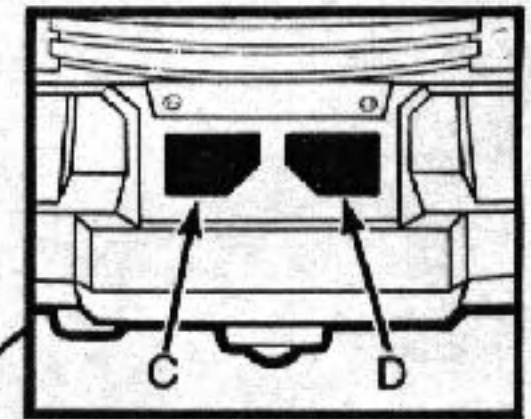
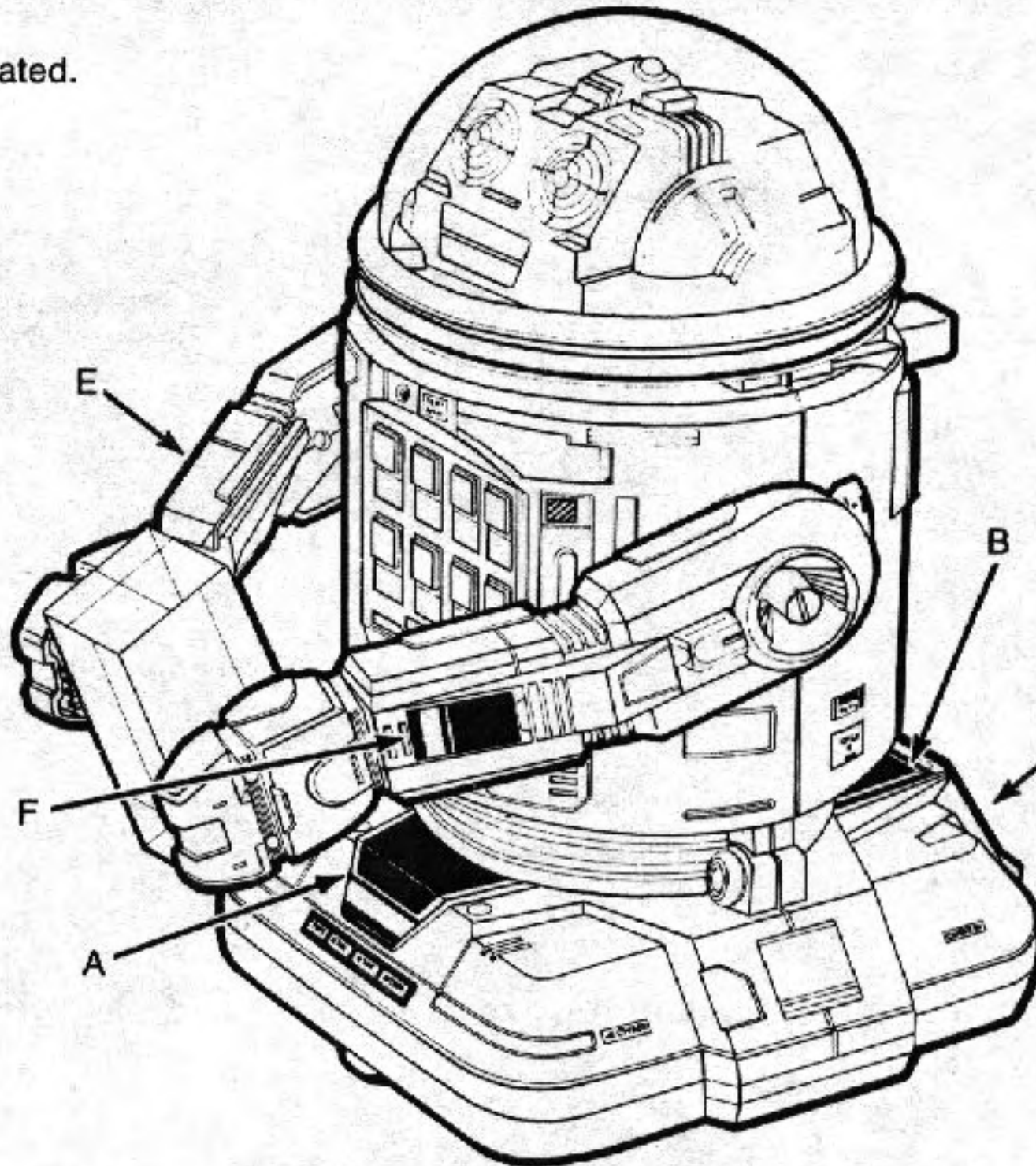
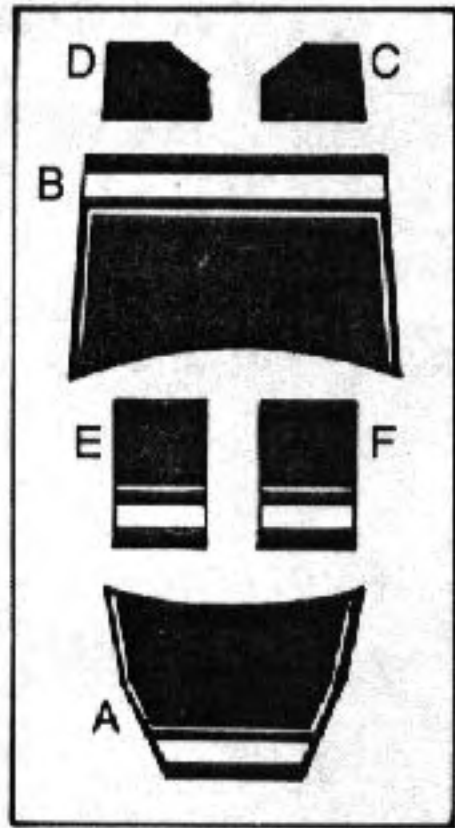

BATTERY INSERTION

You will need: 1 9-volt Alkaline Battery
2 "C" size Alkaline Batteries
4 "AA" size Alkaline Batteries

Before loading the batteries, make sure that all switches are turned OFF.

VOICE TRANSMITTER

Turn the Voice Transmitter around to the back. Slide Battery Cover Door open and take it off.

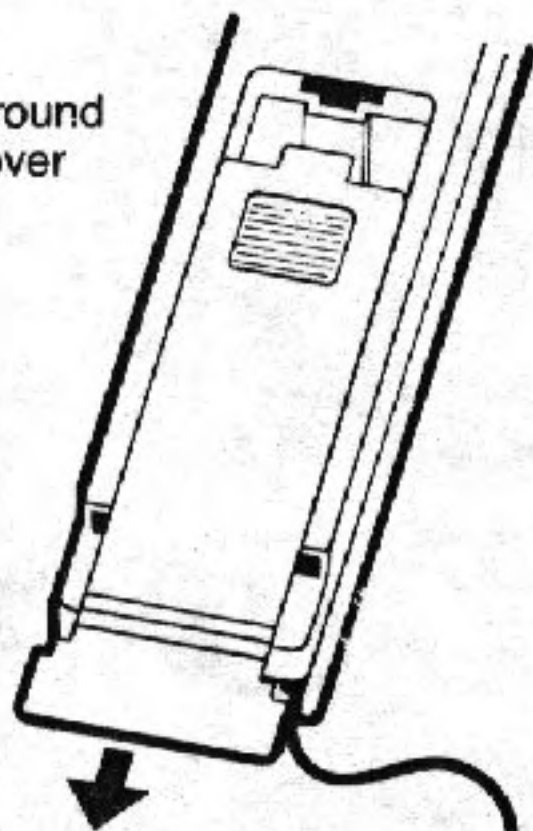

Insert one 9-volt Alkaline Battery as shown. Slide Battery Cover Door back into place and snap shut.

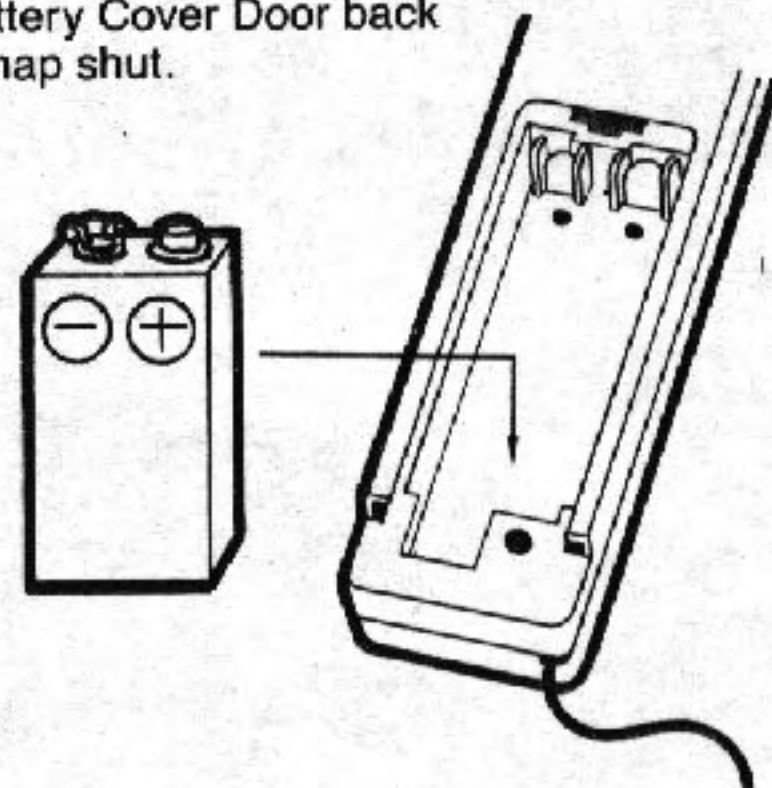

BATTERY INSERTION

VERBOT

Turn Verbot upside down. Slide Battery Cover Door in the direction indicated and open.

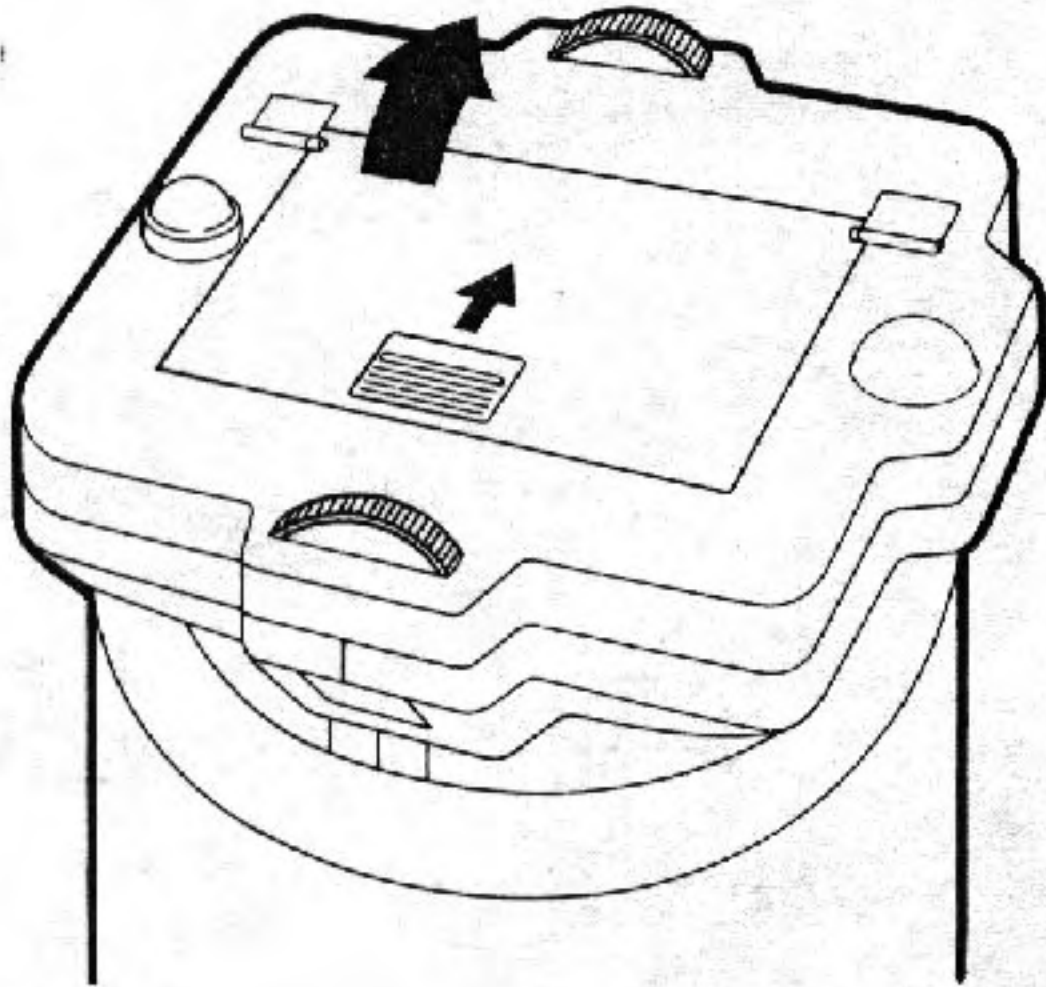

INSERT BATTERIES:

1. Place the 4 "AA" size Alkaline Batteries into their indicated slots.
2. Fit the 2 "C" size Alkaline Batteries into place.

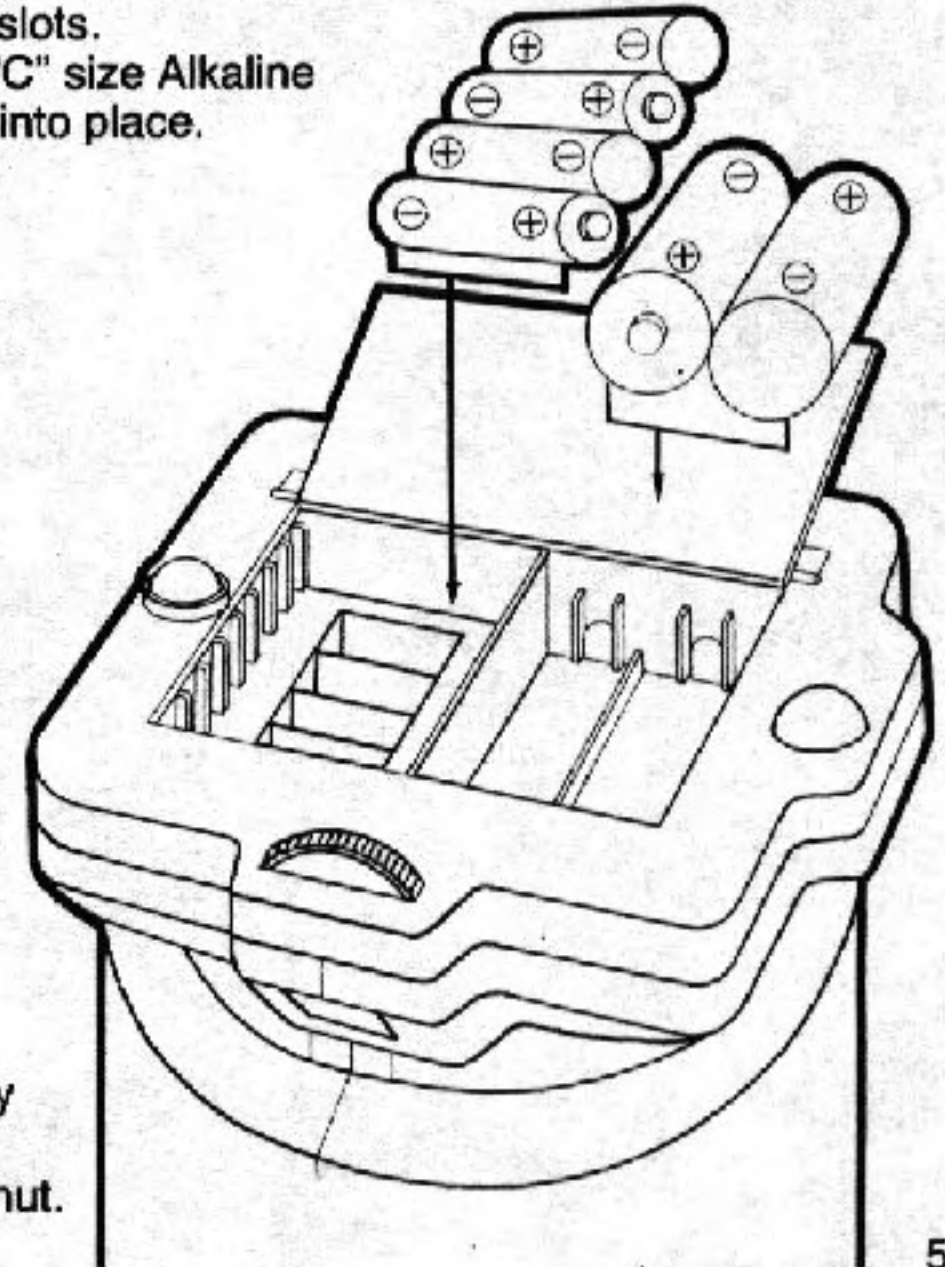

Close Battery
Cover Door
and SNAP shut.

BATTERY REPLACEMENT

When to replace the Batteries:

	BATTERY	SYMPTOMS
VOICE TRANSMITTER	One 9-volt Alkaline	<ul style="list-style-type: none">• The ON/OFF indicator light grows dim.• The Distance necessary to transmit commands becomes shorter.
VERBOT	4 "AA" size Alkaline	<ul style="list-style-type: none">• The ON/OFF indicator light grows dim.• Verbot's memory light stays on and does not flash.• Verbot continually functions improperly.• Verbot moves of its own accord.• Verbot does not respond to commands even after repeated attempts.
	2 "C" size Alkaline	<ul style="list-style-type: none">• Verbot's movements become slower.

The "C" batteries control Verbot's movement. The "AA" batteries control Verbot's voice recognition function. The 9-volt battery controls transmission of voice commands.

BEFORE PROGRAMMING VERBOT, READ ALL OPERATING INSTRUCTIONS.

1. Verbot is programmed by pressing Memory Buttons and entering commands. Under each Memory Button is a small picture of Verbot's function. (See picture below, FIG. 1) You will need to program a separate Command Word (or words) for each Memory Button.

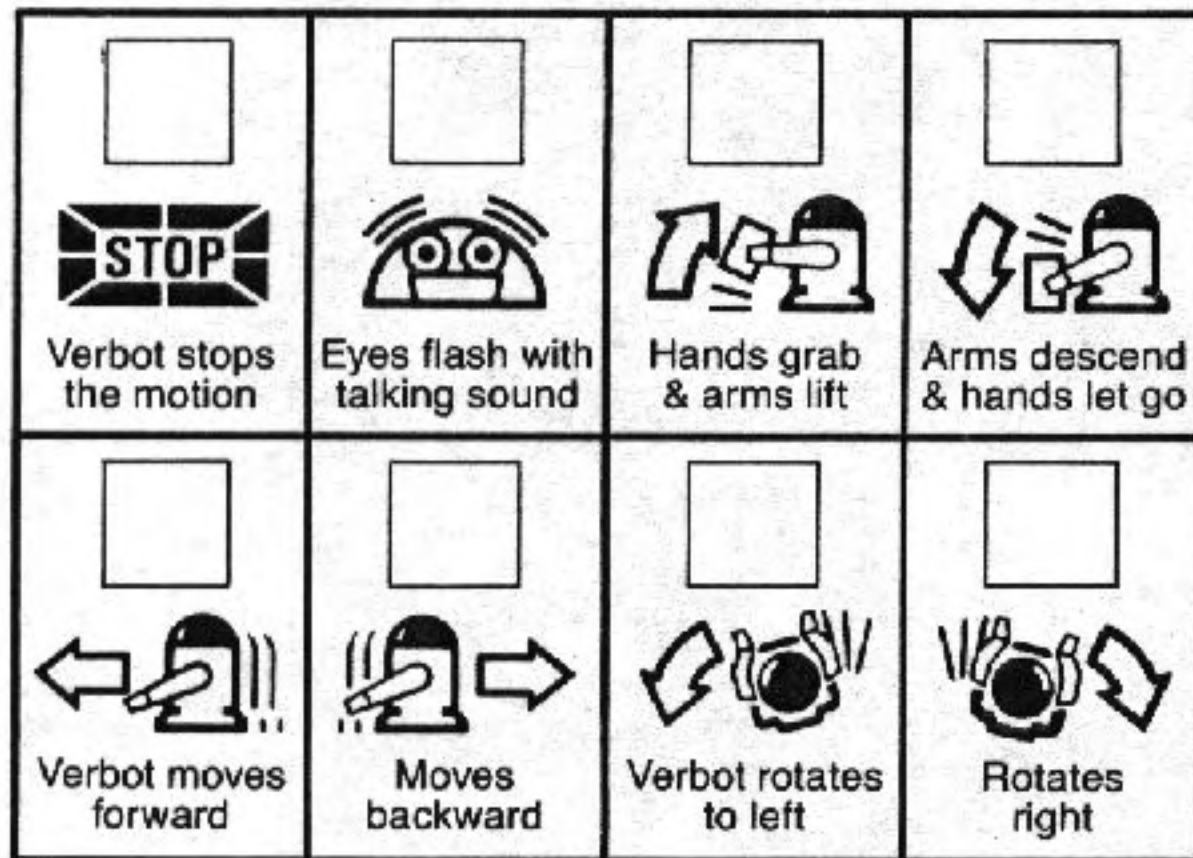

FIG. 1

Choose Command Words that are very short, 2 or 3 syllables at the most.

THE GOLDEN RULE: COMMANDS MUST BE AT LEAST .2 SECONDS LONG, BUT NOT LONGER THAN 1.2 SECONDS. IF YOU PROGRAM A COMMAND LONGER THAN 1.2 SECONDS, VERBOT WILL AUTOMATICALLY ERASE IT.

Also, Command Words should sound very different from each other. For example, don't use "Turn Left" as one command, if you're going to use "Turn Right" as another. They sound too much alike to Verbot, and he may confuse them. ("Rotate Left" and "Turn Right" would be good choices.)

(Continued)

OPERATION (CONT'D)

The following chart (FIG. 2) gives some suggested Command Words:







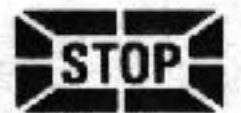

 STOP BOY STAY HOLD IT!	 HELLO THERE SMILE HI YAI	 PICK UP CARRY LIFT IT!	 PUT DOWN PLACE DOWN BOY!
 GO STRAIGHT FORWARD GET MOVIN'!	 BACKWARD REVERSE BACK-UP	 TURN LEFT ROTATE LEFT SWING LEFT	 RIGHT RIGHT TURN CIRCLE RIGHT

FIG. 2

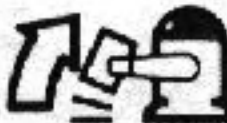
- Turn Verbot's switch to the "ON" position (FIG. 3). Carefully place Verbot on his back (FIG 4).

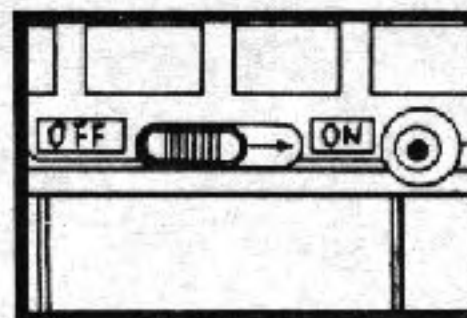

FIG. 3

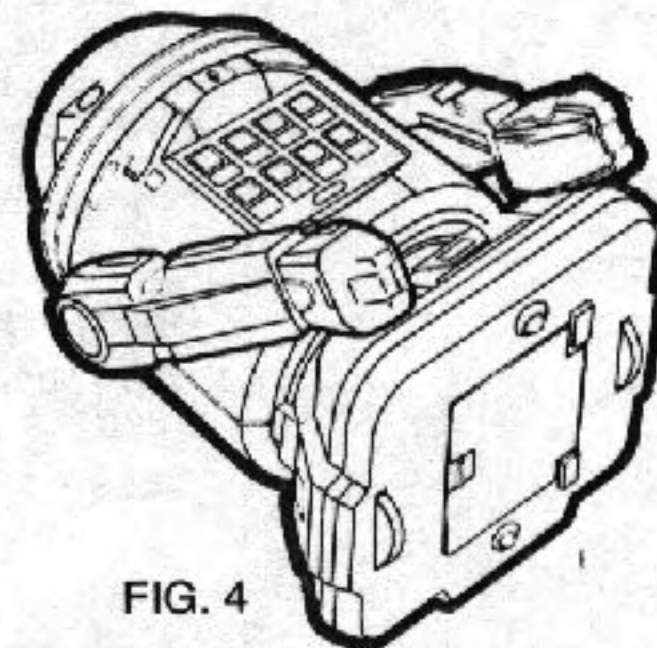

FIG. 4

- Turn the Voice Transmitter's switch to the "ON" position (FIG. 5).

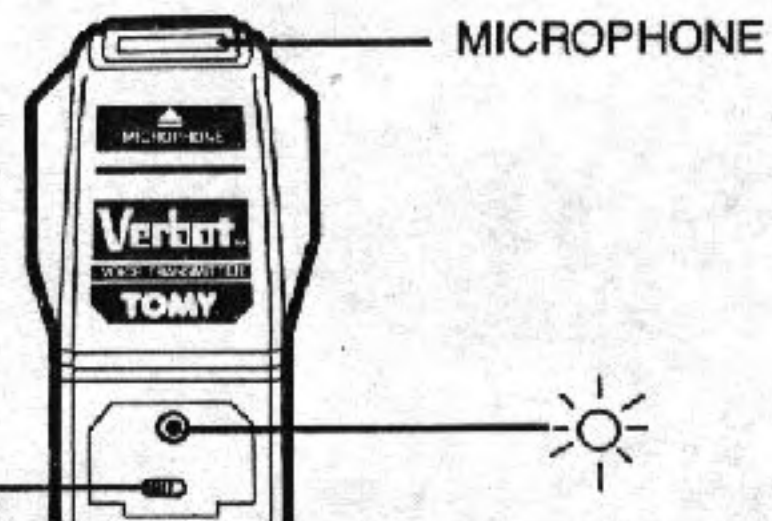

FIG. 5

OPERATION (CONT'D)

4. Follow steps A, B and C to program Verbot:

- A. Hold the first Memory Button (the "STOP" Button) down (FIG. 6). The Memory Light will begin flashing. While the Memory Light flashes, speak into the Voice Transmitter's microphone (FIG. 7). Say the Command Word (s) that you want Verbot to memorize (such as "STOP BOY!" or "STAY"). Keep your voice loud, speak clearly, and hold the Voice Transmitter 3-6 inches from your mouth.

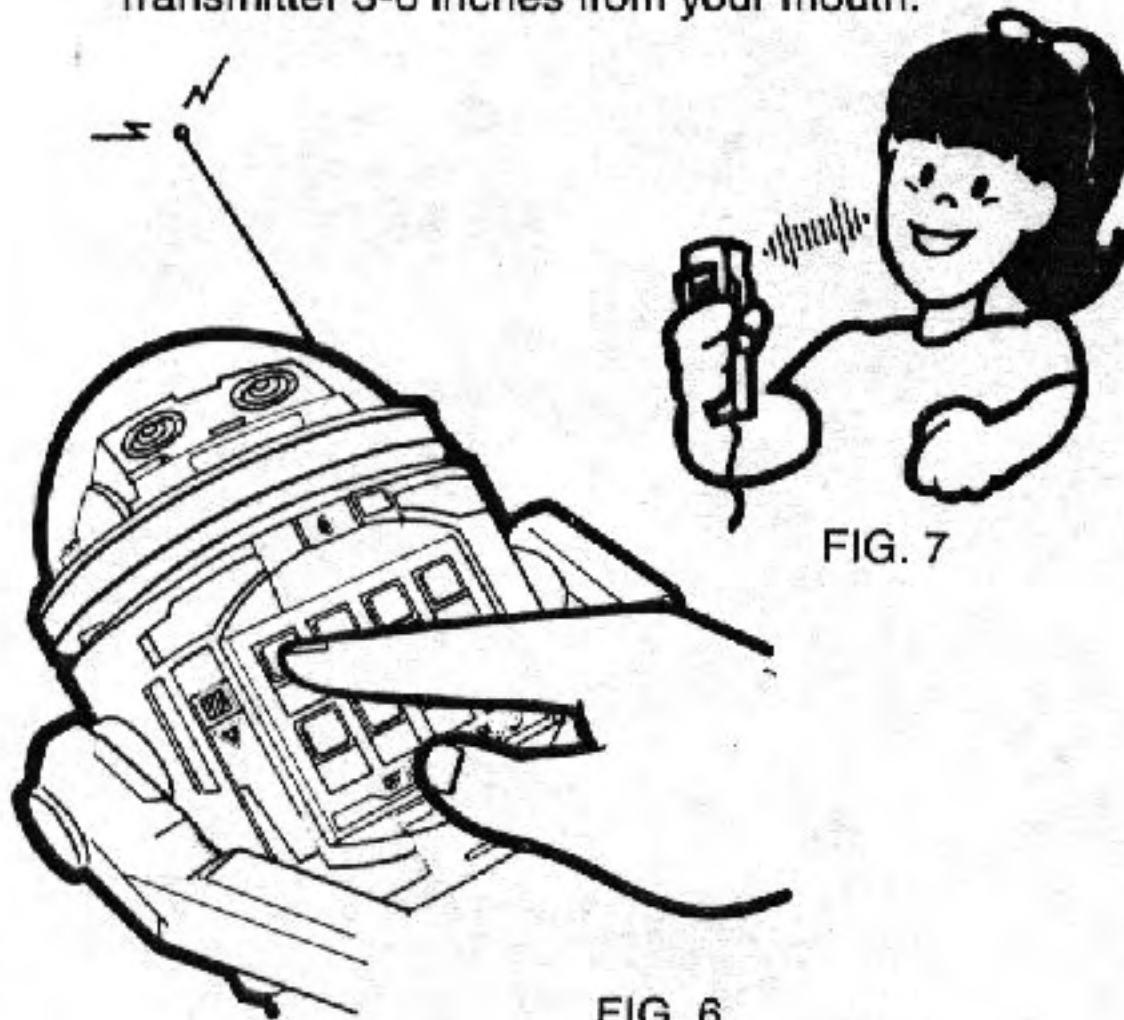

FIG. 6

FIG. 7

- B. Once Verbot memorizes the word, the Memory Light will stop flashing and stay on. If the Light continues to flash, press the Memory Button down again and repeat the Command. Once the Light stays on, the word is programmed. Release the Memory Button to let the Light go off.
- C. Follow steps A and B with each of the remaining Memory Buttons.

YOU WILL FIND BLANK PROGRAMMING CHARTS ON THE BACK COVER OF THE MANUAL. FILL THEM IN TO HELP YOU REMEMBER YOUR COMMAND WORDS.

(Continued)

OPERATION (CONT'D)

5. After you've programmed all 8 Memory Buttons, stand Verbot up for a trial run. Speak into the Microphone in exactly the same tone, accent and wording that you used to program Verbot. The maximum range from Voice Transmitter to Verbot is approximately 12 feet. (Make sure there are no walls or obstacles between the antennas.)

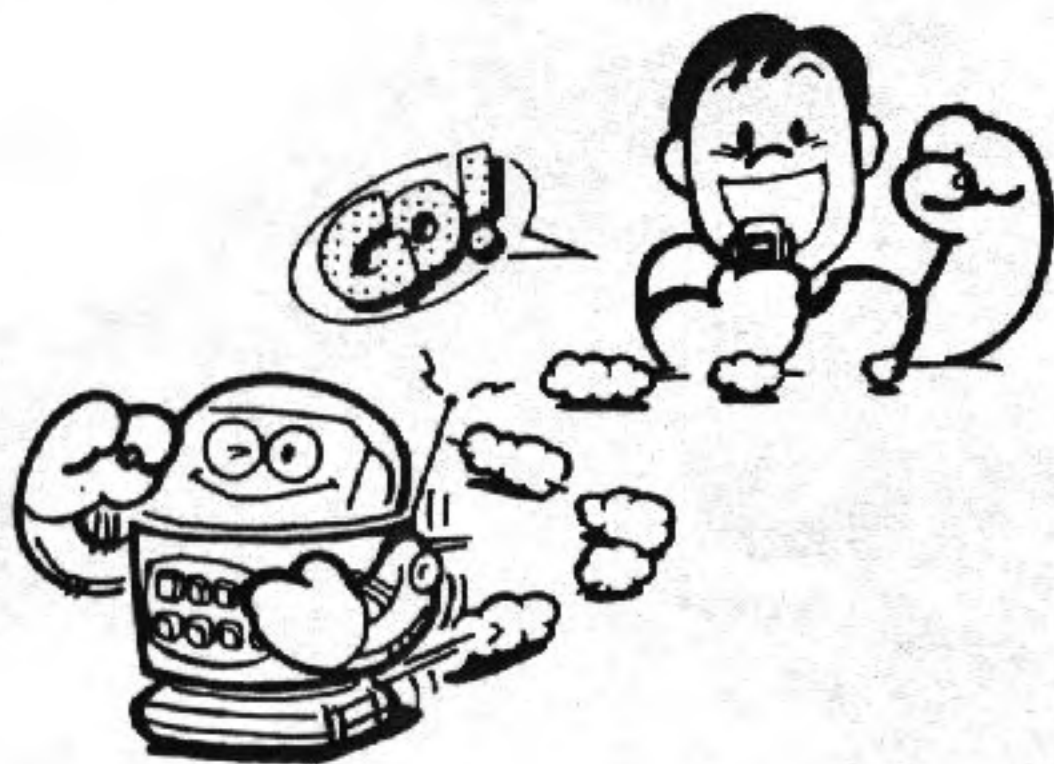

6. If Verbot fails to respond to your Command after several tries (or if he makes the wrong movements), here are some things to try:
 - A. Press the Memory Button again and re-program the word until he gets it.
 - B. Make sure you are making the Command in the same tone, accent and wording as you did when programming Verbot.
 - C. Make sure your Commands are different enough in sound and tone for Verbot to tell them apart.
 - D. Remember or write down the Command Words that you programmed into Verbot.
 - E. Decrease the distance between Verbot and the Voice Transmitter.

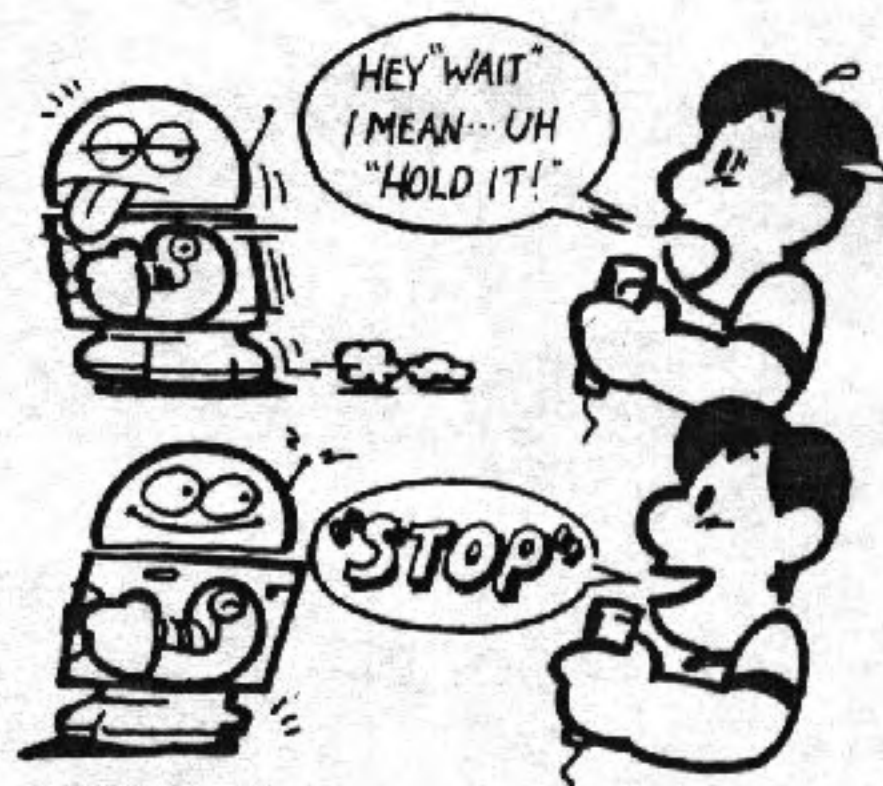

7. When you are finished playing with Verbot, remember to turn BOTH Verbot AND the Voice Transmitter "OFF." (You can not turn Verbot off by giving the Command Word for STOP—You must turn both ON/OFF switches to "OFF.")

REMEMBER: EVERY TIME YOU TURN VERBOT'S SWITCH TO "OFF," YOU ERASE THE PROGRAMMING. Verbot is then ready to be programmed all over again.

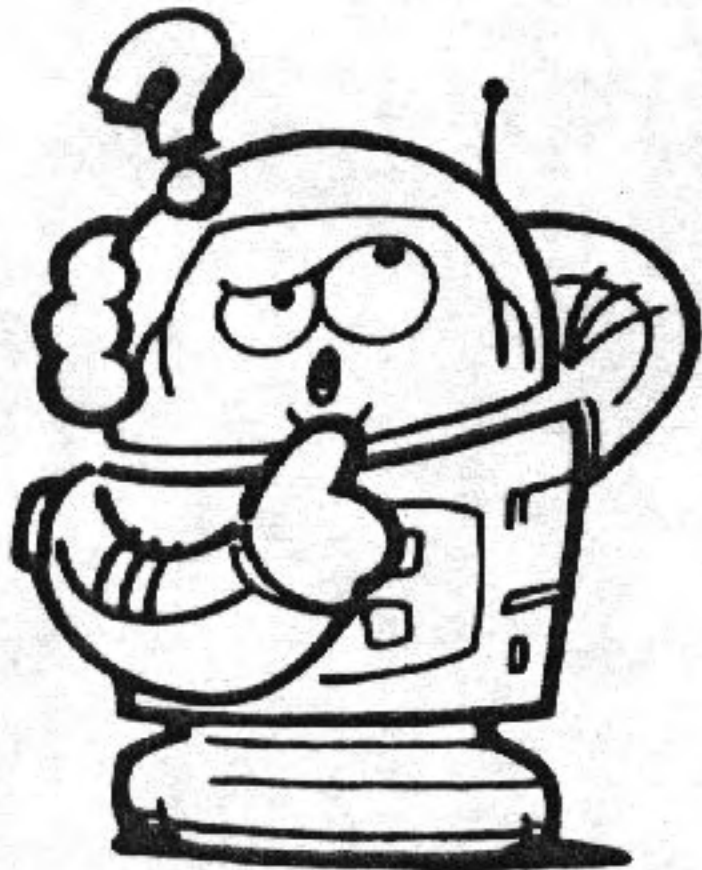

ARM ADJUSTMENT

If the arms slip out of alignment, Verbot may not be able to carry an object effectively (FIG. 8).

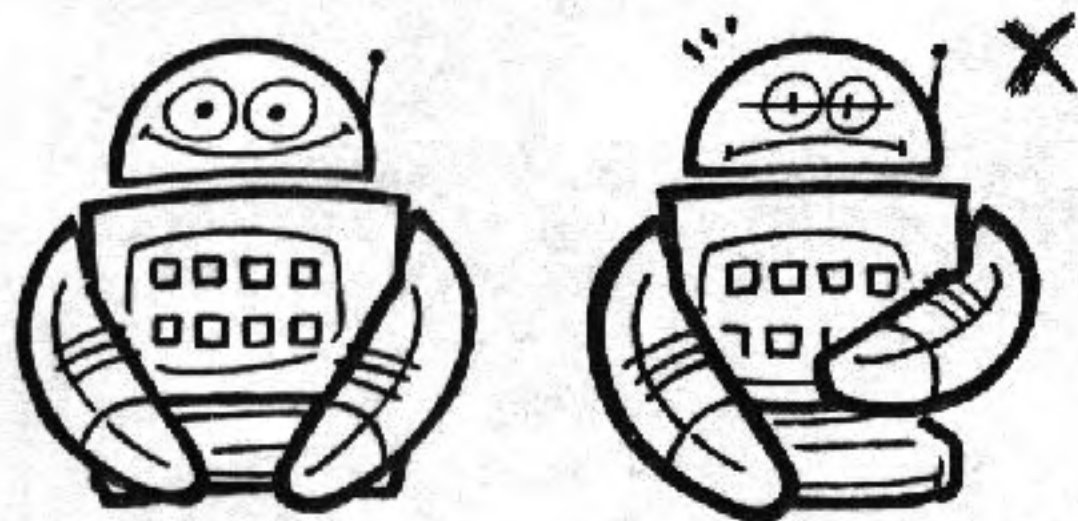

CORRECT POSITION

WRONG POSITION

FIG. 8

Adjust the arms as follows:

Give the Command Word to raise the arms. If the arms come up to the position in FIG. 9, they are in proper position. (The palms of the hands should come together at this point.)

If the arms are too high or too low as in FIG. 10, adjust them with your hands to the correct position (FIG. 9).

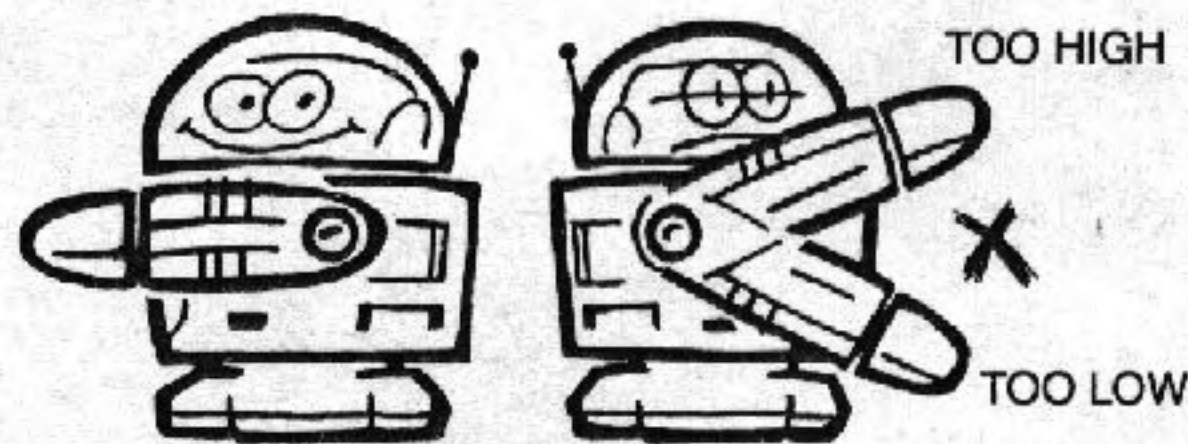

FIG. 9

FIG. 10

1. Do not allow Verbot to carry liquids of any kind. Verbot may be damaged if he gets wet. Keep the Voice Transmitter away from liquids, too.
2. Do not lift Verbot by one arm. This will throw his arms out of position, or may even damage him.
3. Do not overload Verbot with more weight than he can carry.

HINTS, TIPS AND REMINDERS

- Turning Verbot's switch to "OFF" erases all programmed words. Verbot must then be re-programmed.
- Verbot can only memorize short commands of .2 to 1.2 seconds in length. Longer commands erase his memory.
- Saying "STOP" (or giving a stop Command Word) will not turn Verbot off. You must turn Verbot's switch and the Voice Transmitter's switch to "OFF" to turn off the power.
- Do not allow Verbot to carry liquids which can spill. If Verbot or the Voice Transmitter gets wet, it will cause damage.
- The best place for playing with Verbot is indoors, on a flat surface (tiled floors, hardwood floors, vinyl floors, etc.).
- Avoid high resistance surfaces such as hi-pile carpeting, that may prevent Verbot from moving smoothly.
- Avoid inclines, hills or ramps.
- Do not play with Verbot on sandy or gravelly ground. Avoid playing where there is a lot of dust.
- Verbot's performance may be affected by interference from other sources such as cordless phones, and large motorized appliances. If this happens, move to another location.
- Two or more Verbots can not operate in the same location at the same time. Their radio signals will interfere with each other's performance.
- When giving a Command, you must use the same tone, accent and wording that you used to program Verbot's memory. Verbot may or may not respond to the commands of someone else.
- Blowing into the microphone may cause Verbot to make the wrong movements.
- Take the microphone away from your mouth after you finish giving your command. Talking near the microphone may cause Verbot to make the wrong movements.
- If Verbot walks into an obstacle, he will begin to emit a clicking sound. This is a safety feature that protects Verbot's inner mechanisms. This clicking sound also alerts you that Verbot is 'stuck.' Simply pick him up and aim him in another direction; or give him another command (like "Backward" or "Stop").

CHECKLIST FOR CORRECTING DISORDERS

COMPLAINT	CAUSE	CHECK
<p>Verbot does not accept programming. (will not memorize the word)</p>	<ol style="list-style-type: none"> 1. The Transmitter Switch is OFF. 2. There is Radio Frequency interference. 3. The Command is too short or too long. 4. The two antennas are touching each other. 5. The batteries are running low. 	<ol style="list-style-type: none"> 1. Turn the switch ON. 2. Try it in a different place or at a different time. 3. Limit the Command to a maximum of 1.2 seconds, and longer than .2 seconds. 4. Separate the two antennas. 5. Replace the batteries with new ones. (Refer to section on Battery Replacement).
<p>Verbot does not make proper movements.</p>	<ol style="list-style-type: none"> 1. It is the wrong Command. 2. There is Radio Frequency interference. 3. The word is not recorded correctly. 4. There is too much noise in the area. 5. The batteries are running low. 	<ol style="list-style-type: none"> 1. Check your programming chart or re-program the Command into Verbot. 2. Try it in a different place or at a different time. 3. Enter the wording once again. 4. Move to a quieter area. 5. Replace the batteries with new ones. (Refer to section on Battery Replacement).

CHECKLIST FOR CORRECTING DISORDERS

COMPLAINT	CAUSE	CHECK
Verbot does not move.	<ol style="list-style-type: none"> 1. The switch (es) is turned OFF. 2. No words have been programmed into Verbot. 3. The transmitting distance is too far. 4. The batteries are running low. 	<ol style="list-style-type: none"> 1. Turn both switches ON. 2. Program Verbot with the Memory Buttons. 3. Get closer—transmitting should be within an unobstructed 12 foot radius. 4. Replace the batteries with new ones. (Refer to section on Battery Replacement).
Verbot can not carry an object.	<ol style="list-style-type: none"> 1. The arms have slipped out of place. 2. The arms are positioned too high. 3. The arms are positioned too low. 4. The object is too heavy. 	<ol style="list-style-type: none"> 1. Refer to the section on Arm Adjustment.

If after consulting "Checklist for Correcting Disorders" a problem still exists, CALL US. Do not return the product unless asked to do so.

TOLL FREE # 800 421-5597

CALIFORNIA RESIDENTS CALL 800 421-8496

CARE & MAINTENANCE

TAKING CARE OF VERBOT

Verbot has been made with special components which require extra special care. Always keep the following precautions in mind:

1. Do not drop or shake Verbot or the Voice Transmitter.
2. Never take Verbot or the Voice Transmitter apart.
3. Keep them away from dust and moisture.
4. Do not leave them for lengthy periods in direct sunlight, or expose them to extreme temperatures.
5. Do not hold, bend or twist the antennas.
6. When Verbot and/or the Voice Transmitter get dirty, surface wash them with a damp cloth. **DO NOT USE LIQUIDS OF ANY KIND TO CLEAN AS THIS MAY CAUSE DAMAGE.**

RADIO FREQUENCY INTERFERENCE

Interference from other sources (indoors or outdoors) may have an effect on the performance and distance it takes to effectively transmit a command to Verbot. Interference may be caused by a number of factors:

1. Change in temperature.
2. Obstructions (walls, structures, etc.).
3. Other waves in the vicinity (cordless telephones, personal computers, large motorized appliances, etc.).

These factors do not indicate that Verbot is out of order. If you suspect that any of these conditions is present, take Verbot to a different location, and try again.

HOW VERBOT RECOGNIZES YOUR VOICE

When programming Verbot, your speech, in sound waves, is electronically analyzed. The sound waves are then converted into digital signals. These digital signals go into Verbot's "Memory."

Later, when a command is given, Verbot decides whether or not it matches the sound waves of a command already in its memory. When the sounds match, a signal is then sent to the mechanism for the appropriate action.

Verbot will not operate correctly unless you pronounce the commands exactly as they were entered into its "Memory."

Practice mastering your word pronunciation or other unique vocal sounds so that Verbot will respond only to you.

Remember, you must re-program Verbot each time you turn him on.

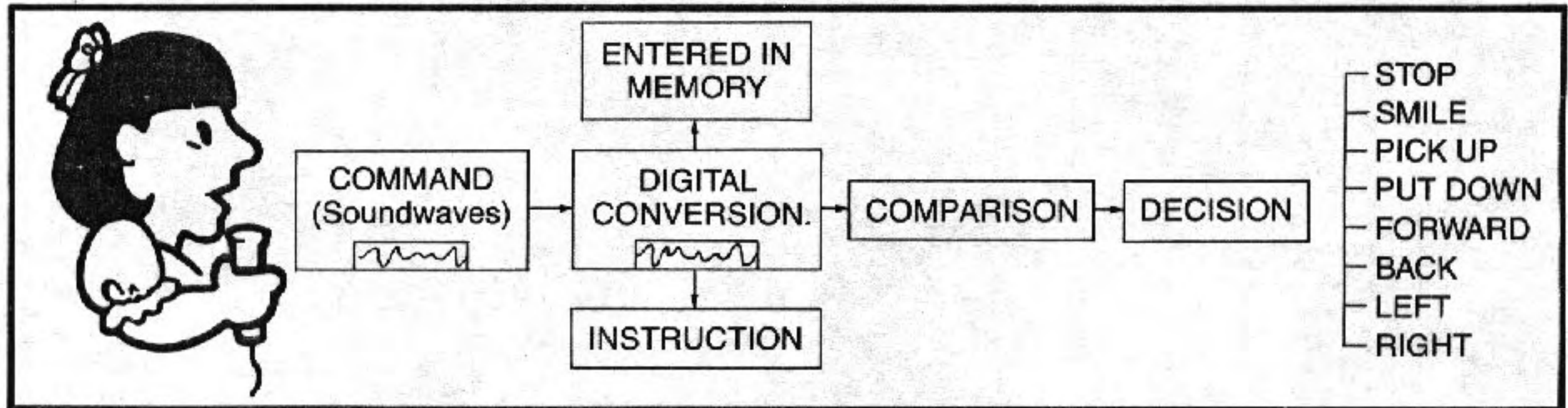

GAMES

ROBOT RELAY

For 1 or more Players

You will need: Paper & Pencil

Small Toys or Objects

Timer, Clock or Watch

OBJECT: To move the objects in the fastest time.

Draw large circles on two pieces of paper. Place them far apart from each other on the floor. Place small toys or objects in one of the circles. Have Verbot carry these objects to the other circle. Time him. To make the game more interesting, set up some obstacles for Verbot to go around. Try to beat the clock, or another player.

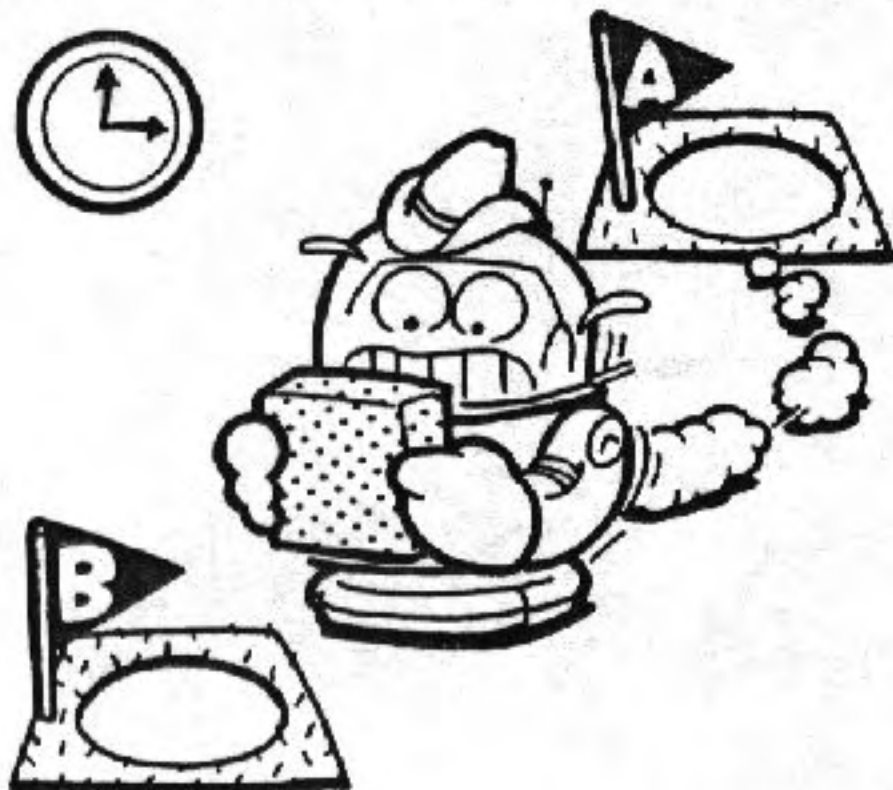

LISTEN UP!

For 2 or more Players

You will need: Paper & Pencil

OBJECT: To successfully imitate Command Words, and get the fewest points.

Have Player 1 program 8 Command Words, or sounds, into Verbot with lots of expression. Player 2 should listen carefully.

Player 2 must then imitate Player 1 exactly, to make Verbot respond. Every unsuccessful try equals 1 point.

Reverse roles. Let Player 2 be the Programmer and Player 1, the Imitator. The person who gets the fewest points wins.

CHALLENGE RULE: The Imitator may challenge the Programmer to see if he (the Programmer) can successfully repeat the Command Word. If he can't, the Programmer must add a point to his score. If he can, the Imitator must take the point.



VERBOT SCRAMBLE

For 2 or more Players

You will need: Pencil & Paper

Clock or Watch

Blocks, Boxes, or Paper Bags

OBJECT: To move Verbot through obstacle course in the shortest amount of time.







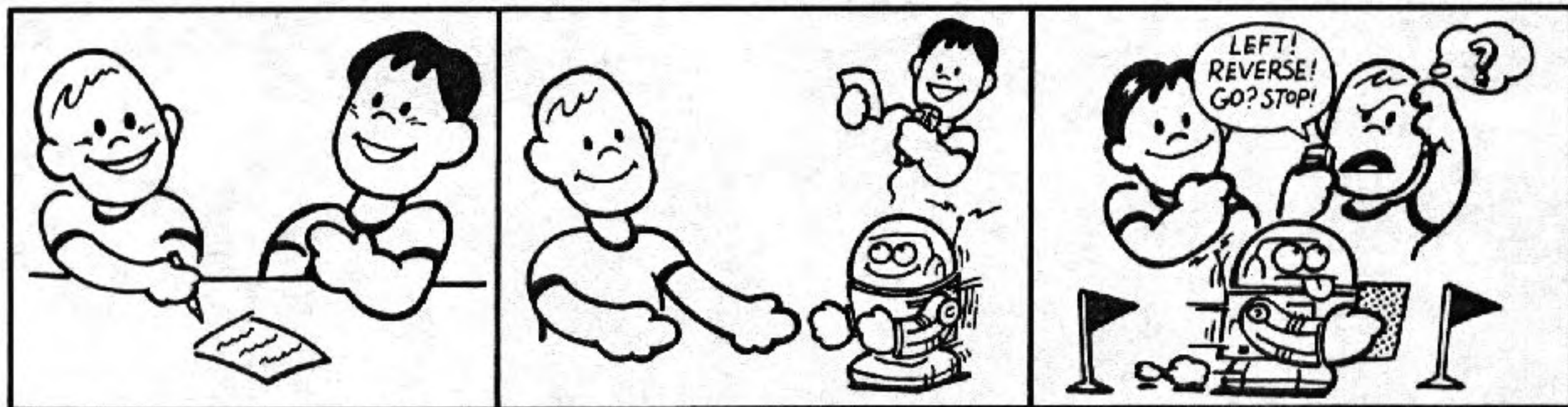

Together, the players think up a list of 8 Command Words. Two players will program Verbot together in the following way: Player 1 will read each word into the microphone, without looking at the Memory Buttons. Player 2 will push the Memory Buttons. Player 2 must mix up the order of each Button pushed, so that Player 1 does not know what Command Word goes with which Button.









Prepare an obstacle course on the floor with toy blocks, boxes and/or paper bags. Player 1 must try to maneuver Verbot through the course. He must discover which Command Words match the movements he needs. Time him.

When Player 1 has finished guiding Verbot through the obstacle course, write down his time. It is now Player 2's turn to speak into the microphone. Player 1 pushes the Memory Buttons. Player 2 must now discover the correct Command Words to maneuver Verbot through the course. The player to get through the course in the shortest amount of time is the winner.



Here are some Programming Charts to fill in to help you remember your Command Words:

			
_____	_____	_____	_____
_____	_____	_____	_____
_____	_____	_____	_____
			
_____	_____	_____	_____
_____	_____	_____	_____
_____	_____	_____	_____

			
_____	_____	_____	_____
_____	_____	_____	_____
_____	_____	_____	_____
			
_____	_____	_____	_____
_____	_____	_____	_____
_____	_____	_____	_____